



DAM12C

Linear throw diffuser with orthogonally arranged adjustable deflectors with a high induction ratio (mixing capacity) between the injected and the ambient air. Made up of a plate with holes inside which adjustable plastic deflectors are housed. The helical flow of the air injected can be oriented clockwise, anticlockwise or alternating by changing the position of the deflectors.

TECHNICAL SPECIFICATION AND USAGE LIMIT

INSTALLATION HEIGHT	APPLICATIONS	MATERIAL	SURFACE FINISH	COLOR	FASTENING
2,5 to 4 m	The diffuser can also be used for air return; in this case it is supplied without deflecting fins. The deflectors can also be oriented after the diffuser has been installed in order to make adjustments to optimise airflow in the room once the system is running.	Painted steel panel, ABS supports and black PVC deflectors	Epoxy powder coating resistant to impact and abrasion	RAL 9010 white. On request, coating in non-standard RAL colors.	by means of side screws or a central screw

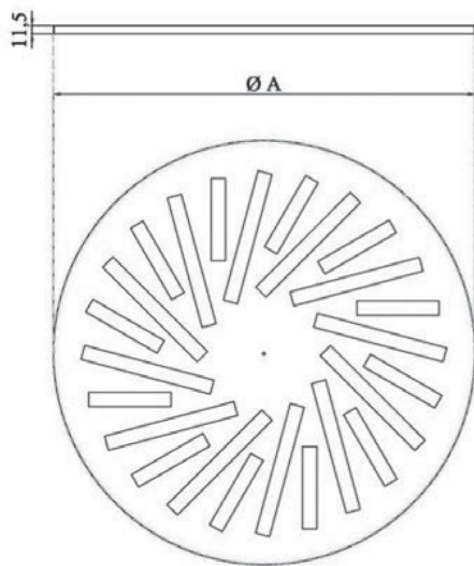

GREEN BUILDING

Thanks also to the support of GreenMap, products manufactured by Tecnica srl contribute to obtain the credits of the major international rating systems for sustainable buildings:



LEED

Contributes to credits:
IP, EA, MR



WELL

Contributes to credits:
MATERIALS, COMMUNITY

BREEAM®

BREEAM









Contributes to credits:
MAN, WST

For further details about specific contributions to the credits indicated, contact Tecnica Srl

TECHNICAL DATA

Model	Ø A [mm]
DAM12C 400	395
DAM12C 500	495
DAM12C 600	595
DAM12C 625	625
DAM12C 800	795

APPLICATIONS

								
Residential	Easy Pack	Calculation Method	REACH Certificate	RoHS Certificate	Industry	Building	Air Conditioning	Interior design

*on request

Selection charts

Flow Rate / Pressure Drop
Air Outlet Speed / Noise Level / Horizontal Throw (Vt.: 0,25m/s)

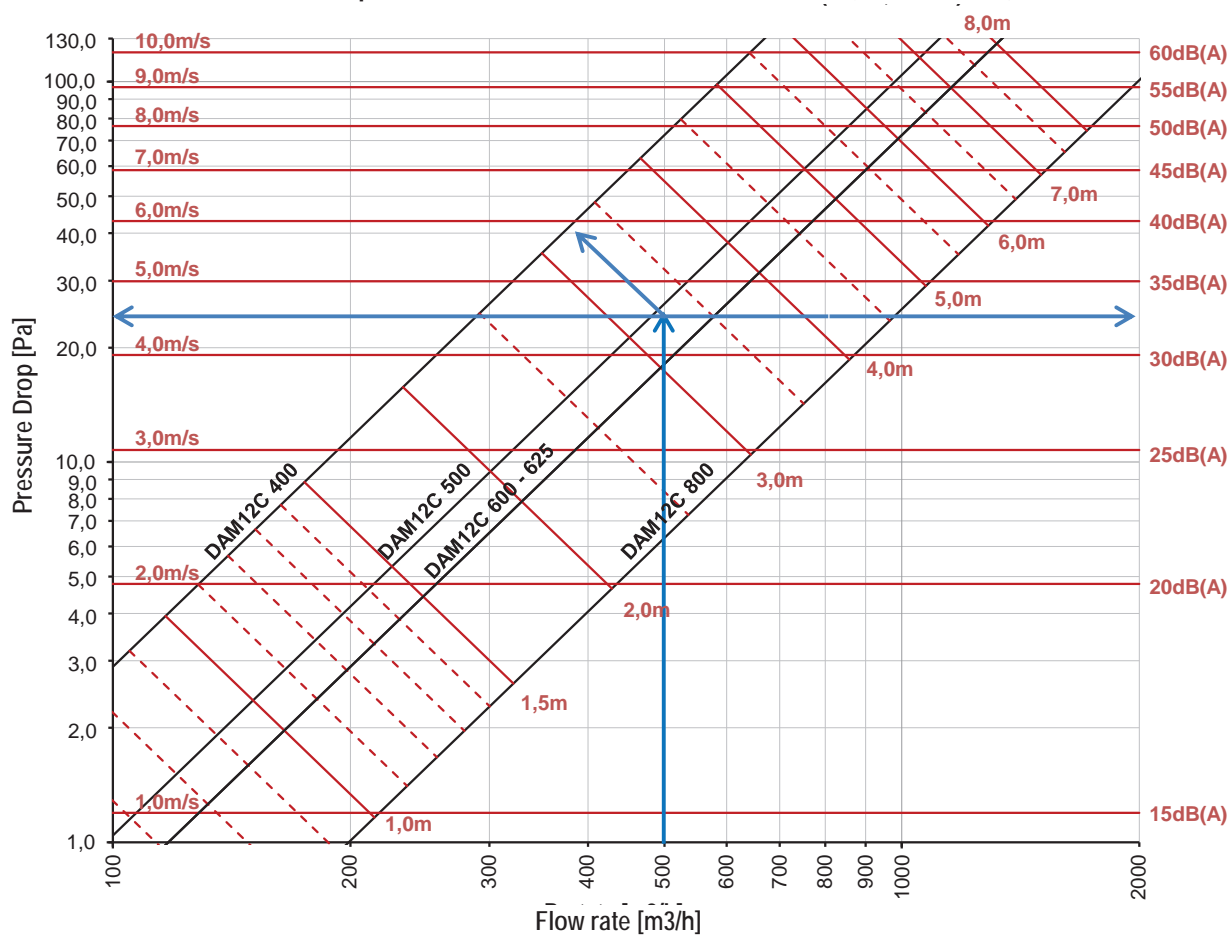

Diagram 1

The diagram shows the diffuser pressure drop based on the flow rate with relative indication of the noise level without environmental attenuation, air outlet speed and horizontal throw with terminal speed equal to 0.25m/s.

Note: Pressure drop data shown in the diagram refer to the diffuser with the damper fully open.

CALCULATION (input data)

Total Flow Rate	5000 m ³ /h
Max Noise Level	35dB(A)
Number of diffusers expected	10pz.
Horizontal Isothermal Throw	3,3m

SELECTION

Model	DAM12C 500
Flow Rate	500 m ³ /h
Pressure Drop	+/- 26Pa
Noise Level	33dB(A)
Inlet Air Speed	Flow Rate/ (Ak * 3600) = 4,67m/s
Horizontal Isothermal Throw	3,3m

MODEL	DESCRIPTION	U.M.	Vi (m/sec)									
			1	2	3	4	5	6	7	8	9	10
DAM12C 400 Ak: 0,0178m ²	Flow Rate	m ³ /h	64	129	193	257	321	386	450	514	578	643
	Pressure Drop	Pa	1	5	11	19	30	43	59	76	97	120
	Horizontal Throw Vt 0,25m/s	mt	0,6	1,1	1,7	2,2	2,8	3,3	3,9	4,4	5,0	5,5
	Noise Level	dB(A)	15	20	25	30	35	40	45	50	55	60
DAM12C 500 Ak: 0,0297m ²	Flow Rate	m ³ /h	107	214	321	428	535	643	750	857	964	1071
	Pressure Drop	Pa	1	5	11	19	30	43	59	76	97	120
	Horizontal Throw Vt 0,25m/s	mt	0,7	1,4	2,1	2,8	3,6	4,3	5,0	5,7	6,4	7,1
	Noise Level	dB(A)	15	20	25	30	35	40	45	50	55	60
DAM12C 600 Ak: 0,0357m ²	Flow Rate	m ³ /h	129	257	386	514	643	771	900	1028	1157	1285
	Pressure Drop	Pa	1	5	11	19	30	43	59	76	97	120
	Horizontal Throw Vt 0,25m/s	mt	0,8	1,6	2,3	3,1	3,9	4,7	5,5	6,2	7,0	7,8
	Noise Level	dB(A)	15	20	25	30	35	40	45	50	55	60
DAM12C 625 Ak: 0,0357m ²	Flow Rate	m ³ /h	129	257	386	514	643	771	900	1028	1157	1285
	Pressure Drop	Pa	1	5	11	19	30	43	59	76	97	120
	Horizontal Throw Vt 0,25m/s	mt	0,8	1,6	2,3	3,1	3,9	4,7	5,5	6,2	7,0	7,8
	Noise Level	dB(A)	15	20	25	30	35	40	45	50	55	60
DAM12C 800 Ak: 0,0604m ²	Flow Rate	m ³ /h	218	435	653	870	1088	1306	1523	1741	1958	2176
	Pressure Drop	Pa	1	5	11	19	30	43	59	76	97	120
	Horizontal Throw Vt 0,25m/s	mt	1,0	2,0	3,0	4,1	5,1	6,1	7,1	8,1	9,1	10,1
	Noise Level	dB(A)	15	20	25	30	35	40	45	50	55	60

Note: the data indicated refer to operation in isothermal conditions

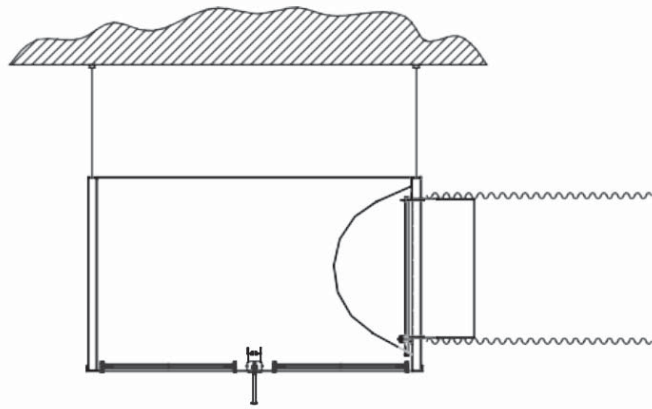

FIG. 1

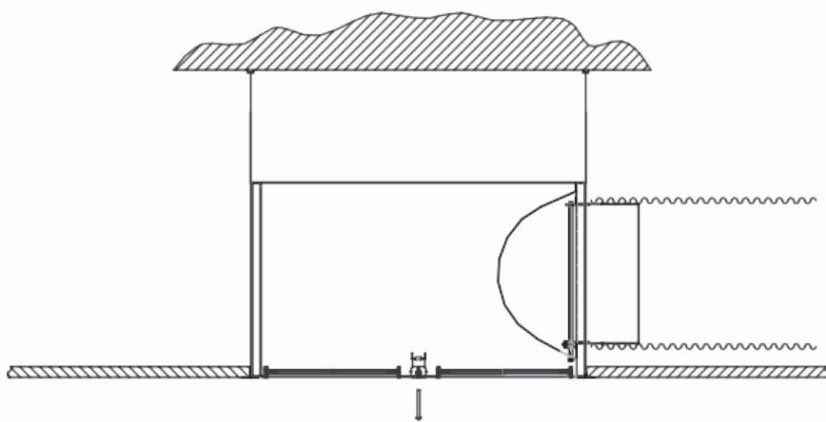
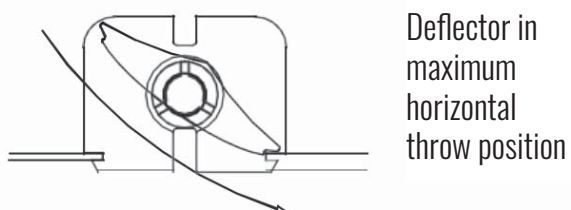
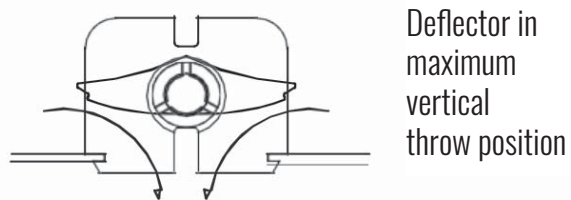

FIG. 2



Deflector in maximum horizontal throw position



Deflector in maximum vertical throw position

FIG. 3

Easy installation, adjustments and maintenance. The diffusers are fastened to the plenum by means of side screws or a central screw.

Adjustment

The airflow distribution is manually adjusted by acting on the deflectors that are fitted with a snap positioning device so that they stay in position during operation.

Fig. 1 Installation with plenum fastened on the ceiling

- Hang the plenum on the ceiling using brackets or chains fastened on the plenum whose outer edge can be drilled.
- Fit the flexible duct on the connecting sleeve and fasten it with a hose clamp.
- Make a preliminary adjustment to the damper by acting on the pin with Allen screw and tightening the hexagonal-head screw that fastens the pin.
- Fit the diffuser using either a central screw screwing it onto the plenum bridge (if provided) or 4 self-tapping side screws.

Fig. 2 Installation on the false ceiling

- Hang the false ceiling elements on the ceiling.
- Make a preliminary adjustment to the damper by acting on the pin with Allen screw and tightening the hexagonal-head screw that fastens the pin.
- Fit the flexible duct on the connecting sleeve and fasten it with a hose clamp.
- Fit the diffuser using either a central screw screwing it onto the plenum bridge (if provided) or 4 self-tapping side screws.
- Rest the diffuser pre-fitted on the plenum on the square space of the false ceiling.

Fig. 3 Movable deflector adjustment

- The movable deflectors can be adjusted from an angle of 0° (maximum vertical throw position used in heating) to a maximum angle (maximum horizontal throw position used in cooling).

The deflectors are fitted with a snap positioning device in order to guarantee accuracy and always correct positioning even with high flow rates and velocities.