



DCSQ

Circular diffuser with adjustable cones made up of concentric truncated cone profiles on a square panel, suitable for installation on false ceilings with 600x600mm panels.

Height adjustable by means of an adjustment screw in order to change the direction of the air jet in relation to the required thermal conditions.

TECHNICAL SPECIFICATION AND USAGE LIMIT

INSTALLATION HEIGHT	APPLICATIONS	MATERIALS	SURFACE FINISH	COLOR	FASTENING
2,7 to 6 m	Room cooling and heating	Aluminium and steel	Epoxy powder coating resistant to impact and abrasion	Standard RAL 9010 - glossy RAL 9016 - glossy RAL 9003 - mat	by means of screws positioned on the diffuser neck

GREEN BUILDING

Thanks also to the support of GreenMap, products manufactured by Tecnica srl contribute to obtain the credits of the major international rating systems for sustainable buildings:

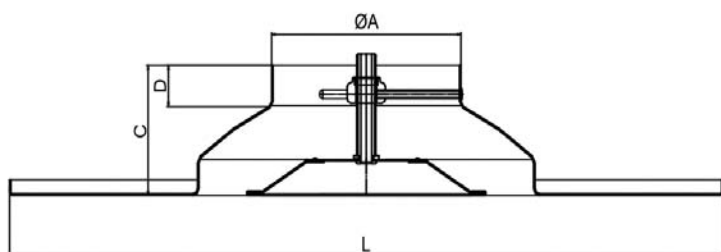

LEED

Contributes to credits:
IP, EA, MR



WELL

Contributes to credits:
MATERIALS, COMMUNITY

BREEAM

BREEAM









Contributes to credits:
MAN, WST

For further details about specific contributions to the credits indicated, contact Tecnica Srl

TECHNICAL DATA

Model	Ø A [mm]	Ø B [mm]	C [mm]	D [mm]
DCSQ 100	96	595x595	85	33
DCSQ 150	146	595x595	90	23
DCSQ 160	156	595x595	90	28
DCSQ 200	196	595x595	115	37
DCSQ 250	246	595x595	135	37

APPLICATIONS

								
Residential	Easy Pack	Calculation Method	REACH Certificate	RoHS Certificate	Industry	Building	Air Conditioning	Interior design

*su richiesta

Selection charts

Flow Rate / Pressure Drop
Noise Level / Air Speed

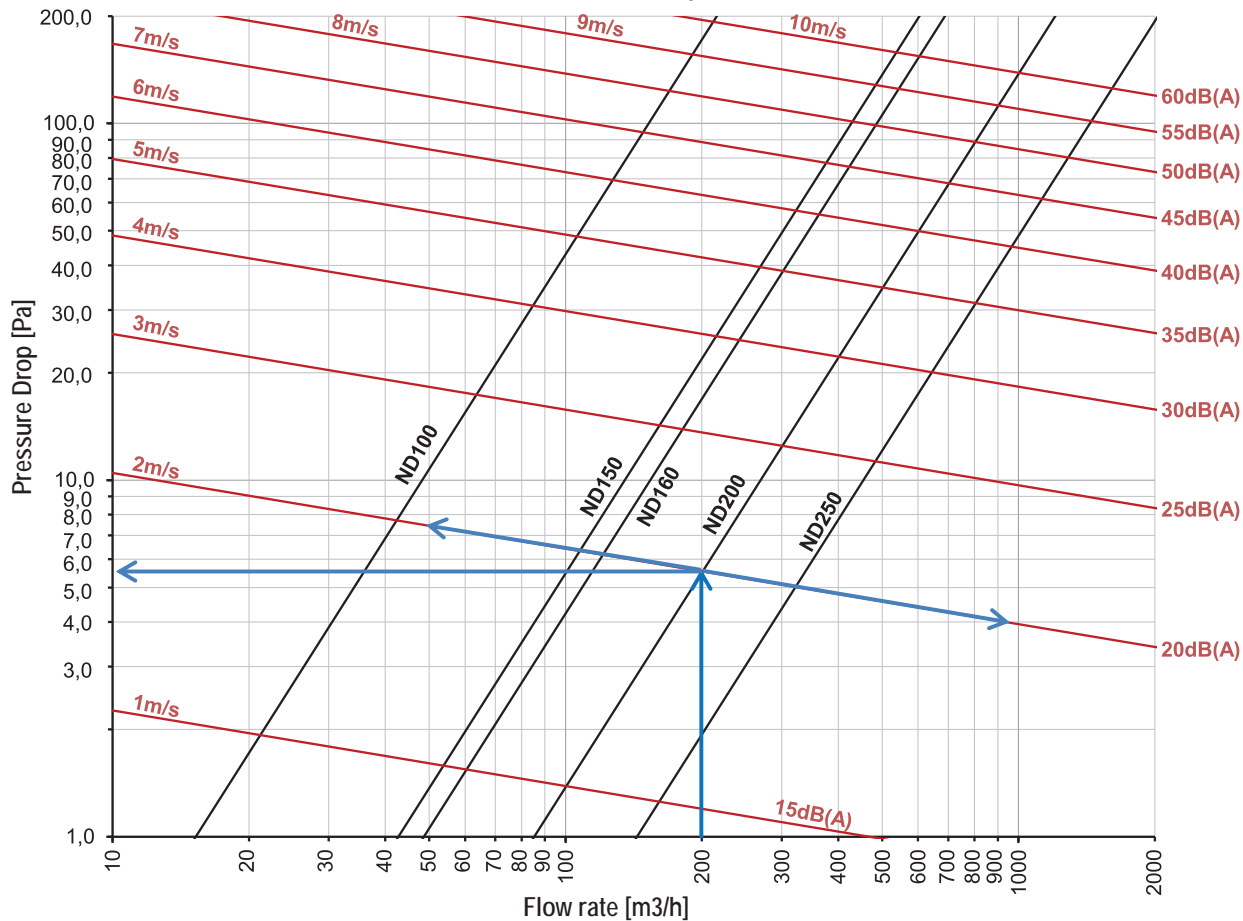

Diagram 1

The diagram shows the pressure drop of the diffuser based on the flow rate with relative indication of the noise level without environmental attenuation and speed of the incoming air flow.

CALCULATION (input data)

Total Flow Rate	2000 m ³ /h
Max. Noise Level	20dB(A)
Number of diffusers expected	10pz.
Throw	1,20m

Flow Rate / Isothermal Throw (Vt.: 0,25m/s)

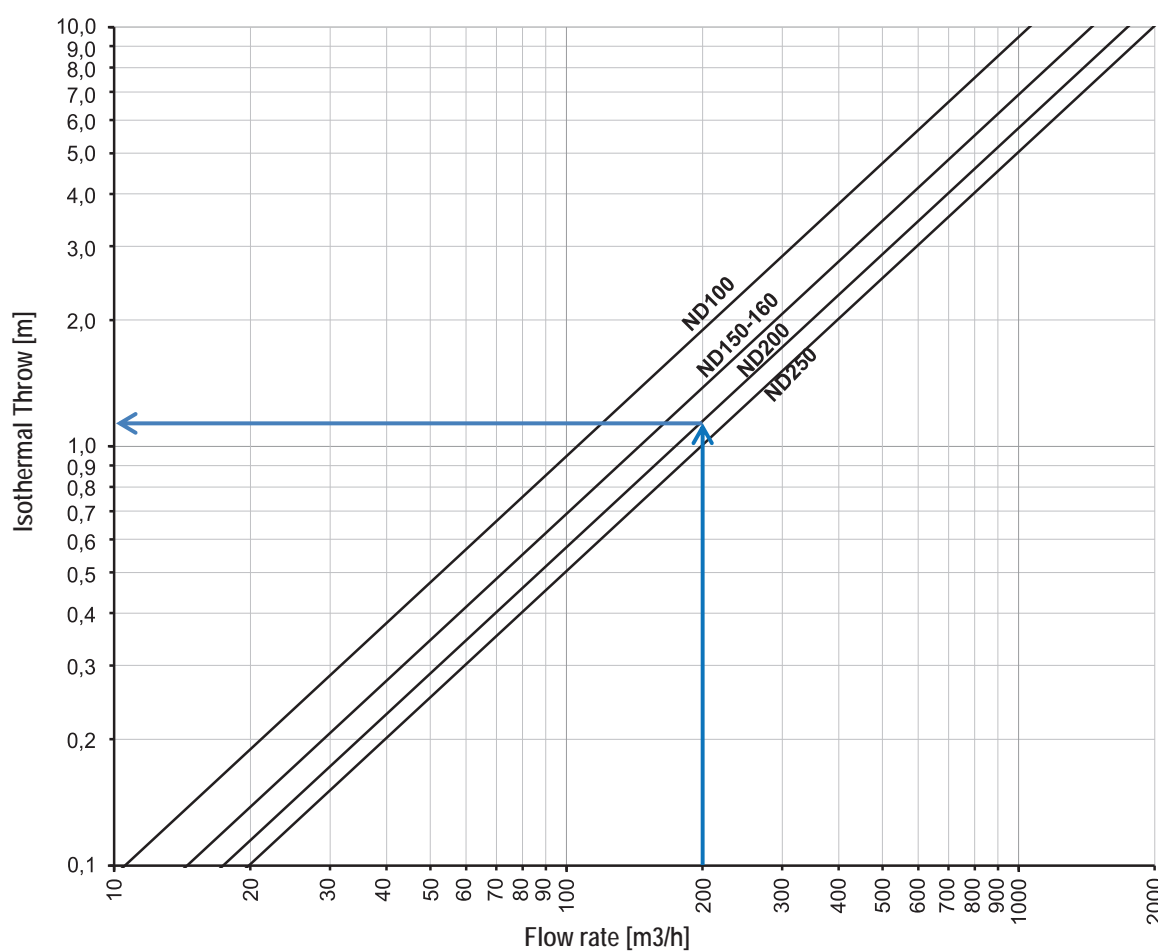

SELECTION

Model	DCSQ 200
Flow Rate	200 m ³ /h
Pressure Drop	+/- 5,5Pa
Noise Level	20dB(A)
Air Speed	2,0m/s
Isothermal Throw	+/- 1,20m

Diagram 2

The diagram shows the isothermal launch of the diffuser according to the flow rate with terminal speed (Vt) of 0,25m/s. The horizontal launch data are to be understood in isothermal conditions.

For $\Delta T < 10^{\circ}\text{C}$ multiply the horizontal throw by 0,85.

NOTE: Pressure drop data shown in the diagram refer to the diffuser with the damper fully open.

MODEL	DESCRIPTION	U.M.	Vi (m/sec)									
			1	2	3	4	5	6	7	8	9	10
100 Ak: 0,0059m ²	Flow Rate	m ³ /h	21	42	63	84	105	127	148	169	190	211
	Pressure Drop	Pa	1,9	7,6	17,2	30,6	47,7	68,7	93,6	122,2	154,7	191,0
	Horizontal Throw Vt 0,25	mt	0,2	0,4	0,6	0,8	1,0	1,2	1,4	1,6	1,8	2,0
	Noise Level	dB(A)	15	20	25	30	35	40	45	50	55	60
	Min. Installation height	mt	2,5	2,6	2,7	2,8	2,9	3,0	3,1	3,2	3,3	3,4
	Max. Installation height	mt	3,2	3,3	3,4	3,5	3,6	3,7	3,8	3,9	4,0	4,1
150 Ak: 0,0149m ²	Flow Rate	m ³ /h	54	107	161	215	268	322	376	429	483	537
	Pressure Drop	Pa	1,6	6,3	14,2	25,2	39,4	56,8	77,3	101,0	127,8	157,7
	Horizontal Throw Vt 0,25	mt	0,4	0,7	1,1	1,5	1,9	2,2	2,6	3,0	3,3	3,7
	Noise Level	dB(A)	15	20	25	30	35	40	45	50	55	60
	Min. Installation height	mt	2,5	2,6	2,7	2,8	2,9	3,0	3,1	3,2	3,3	3,4
	Max. Installation height	mt	3,2	3,3	3,4	3,5	3,6	3,7	3,8	3,9	4,0	4,1
160 Ak: 0,0167m ²	Flow Rate	m ³ /h	60	120	181	241	301	361	421	482	542	602
	Pressure Drop	Pa	1,5	6,1	13,8	24,5	38,3	55,1	75,0	98,0	124,0	153,1
	Horizontal Throw Vt 0,25	mt	0,4	0,8	1,2	1,7	2,1	2,5	2,9	3,3	3,7	4,1
	Noise Level	dB(A)	15	20	25	30	35	40	45	50	55	60
	Min. Installation height	mt	2,5	2,6	2,7	2,8	2,9	3,0	3,1	3,2	3,3	3,4
	Max. Installation height	mt	3,2	3,3	3,4	3,5	3,6	3,7	3,8	3,9	4,0	4,1
200 Ak: 0,0279m ²	Flow Rate	m ³ /h	100	201	301	402	502	602	703	803	904	1004
	Pressure Drop	Pa	1,4	5,5	12,5	22,2	34,7	49,9	68,0	88,8	112,3	138,7
	Horizontal Throw Vt 0,25	mt	0,6	1,2	1,7	2,3	2,9	3,5	4,0	4,6	5,2	5,8
	Noise Level	dB(A)	15	20	25	30	35	40	45	50	55	60
	Min. Installation height	mt	2,5	2,6	2,7	2,8	2,9	3,0	3,1	3,2	3,3	3,4
	Max. Installation height	mt	3,2	3,3	3,4	3,5	3,6	3,7	3,8	3,9	4,0	4,1
250 Ak: 0,0448m ²	Flow Rate	m ³ /h	161	323	484	645	806	968	1129	1290	1451	1613
	Pressure Drop	Pa	1,3	5,0	11,3	20,1	31,5	45,3	61,7	80,5	101,9	125,8
	Horizontal Throw Vt 0,25	mt	0,8	1,6	2,4	3,2	4,1	4,9	5,7	6,5	7,3	8,1
	Noise Level	dB(A)	15	20	25	30	35	40	45	50	55	60
	Min. Installation height	mt	2,5	2,6	2,7	2,8	2,9	3,0	3,1	3,2	3,3	3,4
	Max. Installation height	mt	3,2	3,3	3,4	3,5	3,6	3,7	3,8	3,9	4,0	4,1

Note: the data indicated refer to operation in isothermal conditions

ASSEMBLY INSTRUCTION

INSTALLATION WITH CONNECTING SLEEVE AND BUTTERFLY DAMPER

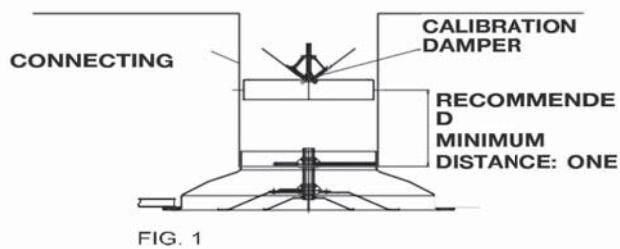

INSTALLATION WITH FLEXIBLE HOSE AND BUTTERFLY DAMPER

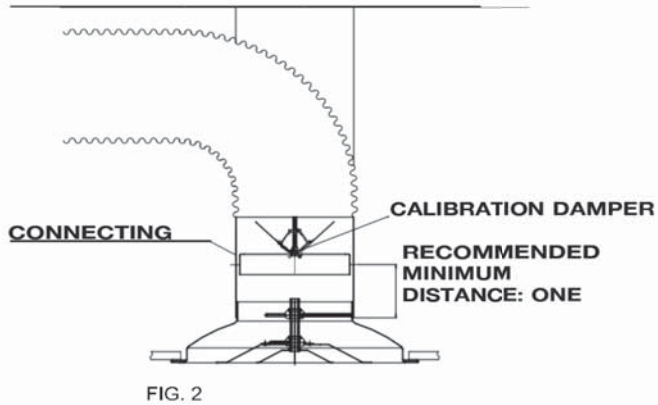

INSTALLATION WITH CONNECTING SLEEVE AND COLLECTION DAMPER

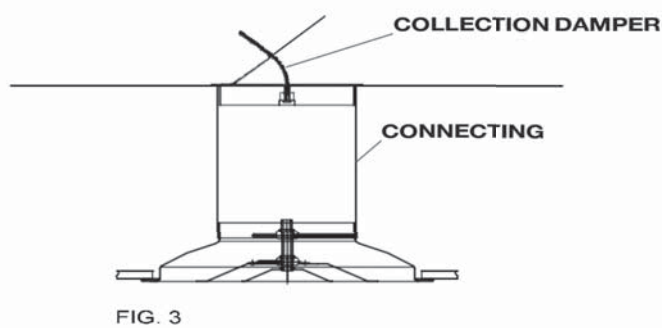

Easy installation, adjustments and maintenance. The intermediate cones are easy to remove by turning the central hollow threaded pin. The damper fitted at the top of the diffuser is adjusted by acting on the adjustment screw through the hole in the threaded bar of the diffuser. It is fastened to the ceiling by means of screws on the diffuser neck.

Adjustment

Central cone in low position: optimal position in cooling conditions in order to have the largest horizontal diffusion radius without creating discomfort in the occupied area in rooms with an ideal height between 3 and 4 m. With this configuration, you have the best pressure drop, velocity and sound level conditions. The maximum temperature difference (DI) between the ambient air and the air flowing from the diffuser to obtain the optimal induction conditions is 12°C.

Central cone in high position: optimal position for particularly high rooms up to 6 m and in heating conditions, as you obtain a vertical throw that resists the convective motion of the ambient air.

Fig. 1 Installation with butterfly damper

- Fit the damper on the connecting sleeve, if possible keeping a distance with respect to the diffuser of one nominal diameter but not less than 5 cm.
- Unscrew the central cones from the diffuser and fasten the external housing on the connecting sleeve.
- Screw the central cones onto the external housing.
- Adjust the internal cones according to the desired diffusion parameters.
- Adjust the damper through the central hole in the threaded bar of the diffuser.

Fig. 2 Installation on flexible hose with butterfly damper

- Hang the diffuser on the ceiling or fasten it on the false ceiling.
- Fasten the damper on the connecting sleeve.
- Fit the connecting sleeve in the diffuser.
- Fit the flexible duct on the connecting sleeve and fasten it with a hose clamp.

Fig. 3 Installation with connecting sleeve and collection damper

- Fit the damper on the connecting sleeve in proximity of the hole in the main duct and fasten it with screws or rivets.
- Adjust the damper.
- Fasten the diffuser on the connecting sleeve.
- Finally adjust the flow rate by acting on the damper through the central hole in the threaded bar.